

Operating and Installation Instructions

CAUTION!

This product is to be installed only by persons knowledgeable in the repair and modification of vehicle fuel systems and general vehicle systems modification. Only a qualified technician or mechanic who is aware of applicable safety procedures and fabrication skills should perform the installation of this product.

GASOLINE AND OTHER FUELS ARE FLAMMABLE AND CAN BE EXPLOSIVE!

Perform the installation in a well ventilated location only to minimize the build up of fuel vapors. **NO** open flames, smoking or other sources of ignition are to be present during installation, to prevent fire or explosion that can cause serious injury or death. Grinding, cutting, and drilling must be performed with care to prevent ignition. Draining and removal of all fuel and ventilation of vapors in vehicle and fuel system is recommended when performing such procedures. Proper eye and personal protection is required at all times during installation.

WARNING!

The Vehicle's fuel system may be under pressure! Do not loosen any fuel connections until relieving all fuel system pressure. Consult an applicable service manual for instructions to relieve fuel system pressure safely.

This product is intended for racing, off-road, or marine use only. This fuel system component may not be legal for sale or use on emission controlled motor vehicles; consult local, state and national laws.

This Fuel Surge Tank System is compatible only with Pump or Racing Gasolines, E85 or all Ethanol blends. This Fuel Surge Tank is **NOT** compatible or covered under warranty with use of Diesel or Methanol Fuels

Product Contents:

Check the diagram and list of components (right) to ensure that no components are missing from box. Contact your Fuelab distributor immediately for replacement.

23901 Features:

Compatible With	Model 60711 or 60712 FST System
Recommended Filter	818xx Series with -8AN Inlet Fitting Size
Recommended Bracket	Model 45102 Billet Aluminum Bracket

Before Installation, Plan Entire Fuel System:

This kit is specifically designed to be compatible with either Fuelab Model 60711 or Model 60712 Fuel Surge Tank Systems (290mm tall versions). If this kit is intended to be used with other Models of a Fuelab Fuel Surge Tank System, please contact Fuelab distributor immediately for replacement or consultation. This kit is to work with in conjunction with recommended filter 818xx Series using -8AN Inlet Fitting Size (to

mate with the supplied hose assembly as well as the use of the Fuelab Model 45102 Billet Bracket (to mate up with the correct length of the supplied hose assembly). Use of other filter assembly combination is **NOT** recommended as the hose assembly may have undue force applied that can cause leakage or hose failure. Replacement of supplied hose assembly is **REQUIRED** if other than specified filter and bracket is intended for use.

A complete design plan of entire fuel system must be created for the specific application. Refer to instructions outlined in relevant Product Instructions for proper installation of this kit (including Fuel Surge Tank, Filter and Bracket Assembly).

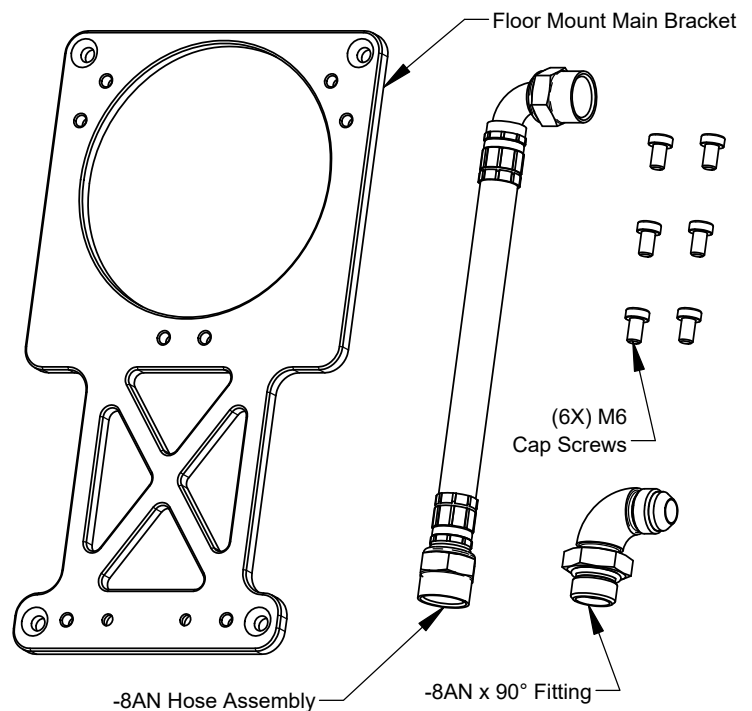

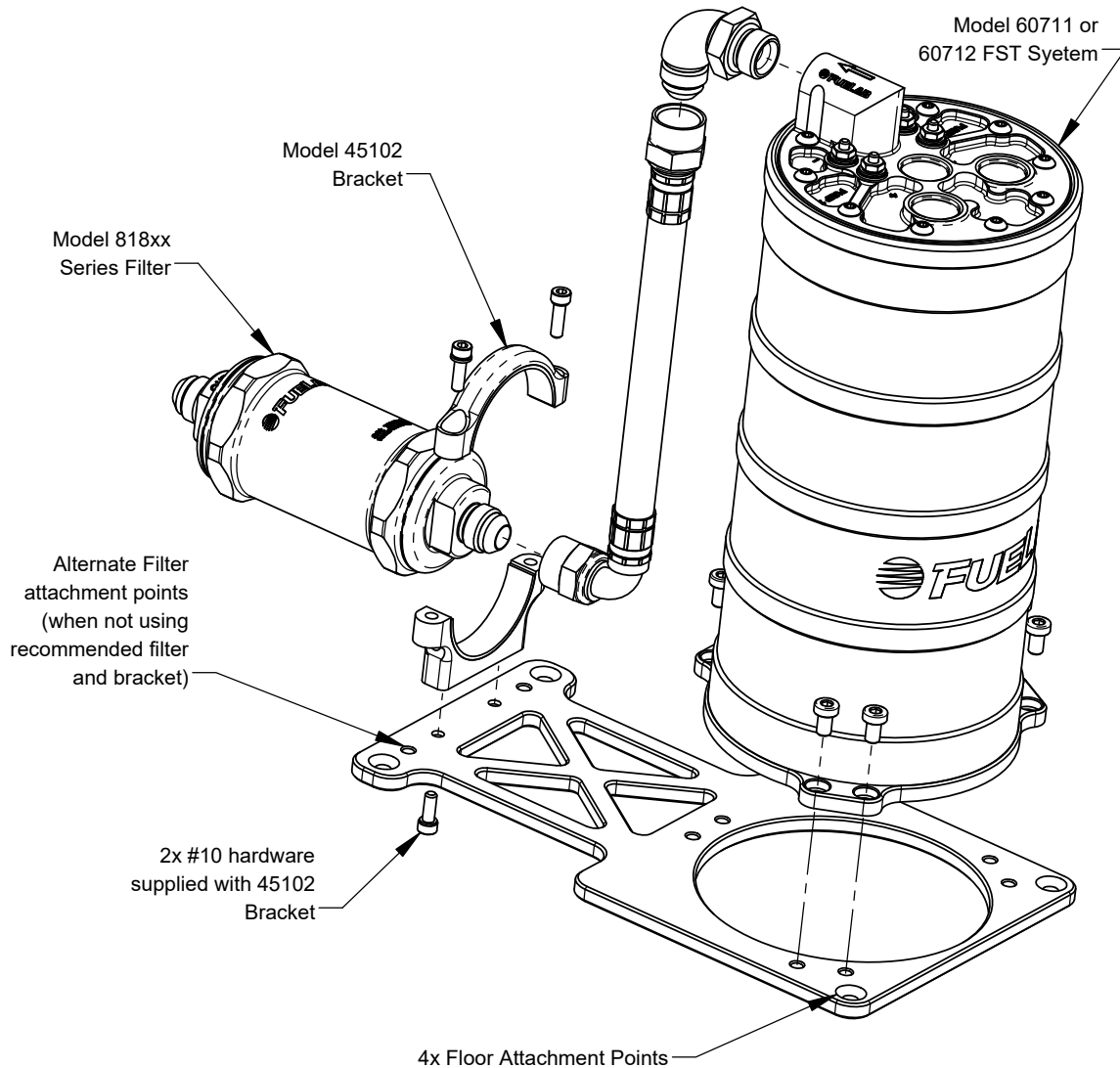

BRACKET SET ASSEMBLY:

Reference above for assembly diagram example. Tighten #10 Screws (supplied with Model 45102 Bracket Kit) and supplied M6 Cap Screws to 40+/-5 in·lbs of torque. Use of thread adhesive for M6 Cap Screws is recommended. Torque -8AN Hose Fittings between 5 and 15 ft·lbs of torque, DO NOT Use thread adhesive nor Teflon Tape on fittings used with supplied Hose Assembly.

Install -8ANx90° Fitting by threading end as shown into FST System Outlet. When fitting is aligned downward (and nearly bottoming of the nut), tighten nut (to above torque specification). Install Hose Assembly, followed by filter assembly. From this point of assembly, M6 Cap Screws and Filter Bracket can be installed to complete assembly. BE SURE TO FOLLOW ALL OTHER INSTALLATION INSTRUCTIONS TO COMPLETE ASSEMBLY.

Please do not return this product to your retailer. If you experience any performance, reliability or problems during installation or use of this product, please contact Fuelab immediately!

For more tips, advice or troubleshooting please visit our website at www.fuelab.com, e-mail message to info@fuelab.com or call our tech department at 618-344-3300 between 8am and 5pm Central Standard Time.

LIMITED WARRANTY

FUELAB, a division of FCP, Inc., having its principal place of business at **1605 Eastport Plaza Drive, Suite 125, Collinsville, IL 62234, USA** ("Manufacturer") warrants its **FUELAB** products (the "Products") as follows:

1. Limited Warranty.

Manufacturer warrants that the Products sold hereunder will be free from defects in material and workmanship for a period of 2 Years from the date of purchase to the original purchaser. If the Products do not conform to this Limited Warranty during the warranty period (as herein above specified), Buyer shall notify Manufacturer in writing, or by phone, of the claimed defects and demonstrate to Manufacturer satisfaction that said defects are covered by this Limited Warranty. If the defects are properly reported to Manufacturer within the warranty period, and the defects are of such type and nature as to be covered by this warranty, Manufacturer shall, at its own expense, furnish replacement Products or, at Manufacturer's option, replacement parts for the defective Products. Removal of Products from vehicle (*Vehicle means any automotive, bike or marine transportation powered by an internal combustion engine. This product is **NOT** intended or designed for use on aircraft, experimental or otherwise.*), shipping to Manufacturer and installation of the replacement Products or replacement parts shall be at Buyer's expense.

2. Other Limits.

THE FOREGOING IS IN LIEU OF ALL OTHER WARRANTIES, EXPRESS OR IMPLIED, INCLUDING BUT NOT LIMITED TO THE IMPLIED WARRANTIES OF MERCHANTABILITY AND FITNESS FOR A PARTICULAR PURPOSE. Manufacturer does not warrant against damages or defects arising out of improper or abnormal use or handling of the Products; against defects or damages arising from improper installation (where installation is by persons other than Manufacturer), against defects in products or components not manufactured by Manufacturer, or against damages resulting from such non-Manufacturer made products or components. Manufacturer passes on to Buyer the warranty it received (if any) from the maker thereof of such non-Manufacturer made products or components. This warranty also does not apply to Products upon which repairs have been effected or attempted by persons other than pursuant to written authorization by Manufacturer.

3. Exclusive Obligation.

THIS WARRANTY IS EXCLUSIVE. The sole and exclusive obligation of Manufacturer shall be to repair or replace the defective Products in the manner and for the period provided above. Manufacturer shall not have any other obligation with respect to the Products or any part thereof, whether based on contract, tort, strict liability or otherwise. Under no circumstances, whether based on this Limited Warranty or otherwise, shall Manufacturer be liable for incidental, special, or consequential damages.

4. Other Statements.

Manufacturer's employees, representatives' and/or resellers ORAL OR OTHER WRITTEN STATEMENTS DO NOT CONSTITUTE WARRANTIES, shall not be relied upon by Buyer, and are not a part of the contract for sale or this limited warranty.

5. Entire Obligation.

This Limited Warranty states the entire obligation of Manufacturer with respect to the Products. If any part of this Limited Warranty is determined to be void or illegal, the remainder shall remain in full force and effect.

6. Warranty Service

What Does This Warranty Not Cover? Any problem that is caused by abuse, misuse, or an act of God (such as a flood) is not covered. Also, consequential and incidental damages are not recoverable under this warranty. Some states do not allow the exclusion or limitation of incidental or consequential damages, so the above limitation or exclusion may not apply to you.

How Do You Get Service? In order to be eligible for service under this warranty you **MUST** return the Warranty Registration card, or register on-line at www.fuelab.com/warranty-registration within 30 days of purchasing the Product.

If something goes wrong with your product contact FUELAB at 618-344-3300, or send an e-mail to: info@fuelab.com for a Return Authorization Number (RMA). After receiving your RMA send it postage paid, fully insured, with a brief written description of the problem to:

FUELAB Warranty Department, 1605 Eastport Plaza Drive, Suite 125, Collinsville, IL 62234

We will inspect your Product and contact you within 72 hours of receipt to give the results of our inspection and an estimate of the labor and/or parts charges required to fix the Product, if applicable. If covered under this limited warranty Manufacturer will repair Product and return it to you at no cost. If the Product is NOT covered under this warranty and if you authorize repairs, we will return the repaired Product to you COD, or prepaid via credit card, within 72 hours. There is no charge for inspection. If return product is found to be free of defects a \$25.00 shipping and handling charge will be applied. We will return the repaired Product to you COD, or prepaid via credit card, within 72 hours.



www.fuelab.com

1605 Eastport Plaza Drive, Suite 125, Collinsville, IL 62234
800-541-2345